

Calculator with Ultrasonic Flow Sensor (Heat Meter, Cooling Energy Meter, Combined Heat/Cooling Energy Meter)

microCLIMA ULTRA/SENSOSTAR[®]2C_US

Certificate no:

DE-09-MI004-PTB018 (MID heat); 22.72/09.01 (National German cooling)

1 Application and Function

Thermal energy meter (heat meter, cooling energy meter or combined heat/cooling meter) designed for the measurement of the consumed thermal energy in a closed heating or cooling or heating/cooling system.

2 Scope of delivery



- Calculator with ultrasonic flow sensor (heat meter, cooling energy meter, combined heat/cooling energy meter)
- Installation kit: 5 self-lock seals + 5 seal-wires; O-ring ; 2 screws + 2 dowels for direct screw mounting
- 2 gaskets for the flow sensor
- Installation and Operating Instructions

3 General Information

- Valid standards for the application of heat meters: EN 1434, parts 1 – 6; the Measuring Instrument Directive 2004/22/EC, Annexes I and MI-004; and the relevant national verification regulations.
- For the selection, installation, commissioning, monitoring and maintenance of the instrument observe the standard EN 1434 part 6 as well as Annex 22 of the verification regulations (for Germany).
- National regulations for the consumption measurement of cooling must be observed.
- The technical regulations for electrical installations are to be observed.
- This product fulfils the requirements of the European Council Directive on Electromagnetic Compatibility (EMC Directive) 2004/108/EC.
- The identification plate of the instrument and the seals must not be removed or damaged – otherwise the guarantee and the approved application of the instrument are no longer valid!
- To achieve measurement stability of the meter is it necessary that the water quality meet the requirements of the AGFW-recommendation FW-510 and the document VDI (Association of German Engineers) VDI 2035.
- The heat meter left the factory in conformance with all applicable safety regulations. All maintenance and repair work is to be carried out only by qualified and authorized technical personnel.
- The instrument must be stored and transported at temperatures above-freezing.
- **Instruments with activated radio function are not allowed on air freight.**
- The correct installation point in the system must be chosen: forward or return flow, as stated on the type identification label.
- The temperature sensor cables and the cable between the calculator and flow sensor must not be kinked, rolled up, lengthened or shortened.
- To clean the heat meter (only if necessary) use a slightly moist cloth.
- To protect against damage and dirt the meter should only be removed from the packaging directly before installation.
- If more than one meter is installed in one unit, care must be taken to ensure that all the meters have the same installation conditions.

- All specifications and instructions listed on the data sheet and in the Application Notes must be adhered to.
- Further information can be obtained at www.engelmann.de.
- Instruments which have been replaced or exchanged must be disposed of according to relevant environmental regulations.
- The display is deactivated and can be activated for one minute by pushing the button (except calculator without additional interfaces).

3.1 Definition of pictograms on type identification label

	Installation in return flow
	Installation in forward flow

4 Mounting of the Flow Sensor

4.1 Safety instructions

- Look out for sharp edges (pipes, flanges).
- Installation and removal should only be carried out by qualified technical personnel.
- Mounting and dismounting may only be carried out without pressure in the heating or cooling system.
- After installation a hydraulic pressure test should be carried out using cold water to check for leaks.
- For safe operation, the instrument must be used only under the stated operating conditions (see section Technical Data). In addition, the guarantee only applies if the allowed operating conditions have been adhered to.
- The security seals may not be damaged, otherwise the guarantee is no longer valid.
- Protection against lightning is not guaranteed; lightning protection must be implemented at the installation site.

4.2 General information on the flow sensor

- Be careful not to pick up the flow sensor on the plastic housing. Always pick up and carry the sensor on the threaded or flanged connections.
- All cables must be laid at a minimum distance of 20 cm to high-voltage current cables.
- If more than one sensor is being installed in a unit, care must be taken to be sure that all the meters have the same installation conditions.
- Overpressure must be applied in order to avoid cavitation in the complete measurement range; this means at least 1 bar up to q_p and approx. 3 bar at overload q_s (specifications for approx. 80°C).
- The flow sensor left the factory in conformance with all applicable safety regulations. Calibration, maintenance, repairs and the exchange of parts may only be carried out by qualified technical personnel who are familiar with the dangers involved. Further technical support can be provided by the manufacturer upon request. Verification seals on the flow sensor may not be damaged or removed – otherwise the guarantee and verification of the instrument no longer apply!

4.3 Technical data of the flow sensor

- Environmental class A (EN 1434), for indoor installation
- Mechanical class M1*)
- Electromagnetic class E1*

* as per Measurement Instrument Directive 2004/22/EU

Flow sensor (refer to the specifications on the sensor)		
Installation point	standard	In return flow
	optional	In forward flow (only for heat meter), calculator must be set in factory
Mounting position heat meter	any	

Mounting position Cooling meter	See section 5 Installation for Cooling Applications	
Straight pipe sections	None required	
Accuracy class	1:100 or 1:50	
Maximum overload	2.8 x q _p	
Nominal pressure	PN 16, PN 25	
Protection class flow sensor	IP54	For heat meter
	IP65	For cooling meter (optional for heat meter)
Max. medium temperature	150°C for 2000 h	
Temperature range (medium)		5°C to 130°C *
	Recommended for heat	10°C to 130°C **
	Recommended for cooling	5°C to 50°C
	* National approvals may vary ** Short model 150 mm only from 20°C to 130°C	
Storage temperature	-20°C to 60°C	
Ambient temperature	5°C to 55°C	
Ambient humidity	< 93% relative humidity	

Nominal flow rate q _p	Overall length	Connection	Maximum flow rate q _s	Minimum flow rate q _i	Response threshold (variable)	Pressure loss at q _p	Kv flow rate at Δp 1 bar	Kv flow rate at Δp 100 mbar	Weight
m ³ /h	mm	G/DN	m ³ /h	l/h	l/h	mbar	m ³ /h	m ³ /h	kg
0.6	110	G 3/4	1.2	6	2.4	150	1.5	0.5	1
	190	G 1							1.5
		DN20							3
1.5	110	G 3/4	3	15	6	150	3.9	1.2	1
	130	G 1							1.5
	190	DN20							3
2.5	130	G 1	5	25	10	200	5.6	1.8	1.5
	190	DN20							3
3.5	260	G 1 1/4	7	35	14	60	14	4.5	3
		DN25							5
6	150	G 1 1/4	12	60	24	240	12	3.9	3
	260	G 1 1/4	12	60	24	180	14	4.5	3
		DN25							5
10	200	G 2	20	100	40	130	28	8.8	2.6
	300					110	30	9.5	4

Nominal flow rate q_p	Overall length	Connection	Maximum flow rate q_s	Minimum flow rate q_i	Response threshold (variable)	Pressure loss at q_p	Kv flow rate at Δp 1 bar	Kv flow rate at Δp 100 mbar	Weight
		DN40				130	28	8.8	7
15	200	DN50	30	150	60	95	49	15.4	5
	270					110	45	14.3	8
25	300	DN65	50	250	100	105	77	24.4	11
40	300	DN80	80	400	160	160	100	31.6	13
60	360	DN100	120	600	240	115	177	56.0	22

4.4 Dimensions

Threaded connection

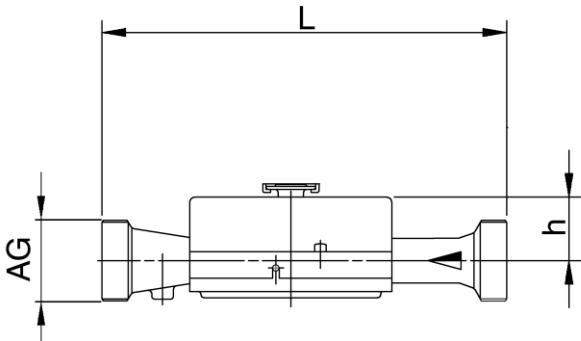

Flange connection

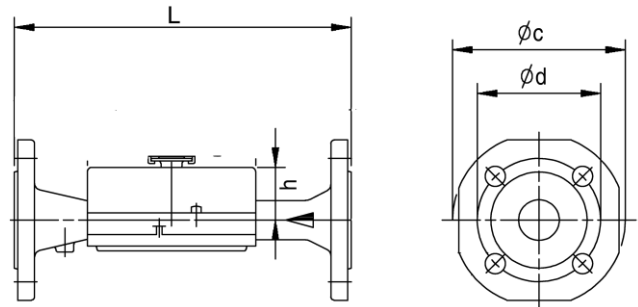

q_p m ³ /h	PN bar	L [mm]	h [mm]	AG
3.5	16	260	51	G 1¼ B
6	16	260	51	G 1¼ B
6	16	150	22	G 1¼ B
10	16	200	48	G 2 B
10	16	300	48	G2B

q_p m ³ /h	PN bar	DN	L	h	ϕ_c	ϕ_d	ϕ_e	no. holes
3.5	25	25	260	51	115	85	14	4
6	25	25	260	51	115	85	14	4
10	25	40	300	48	150	110	18	4
15	25	50	270	46	165	125	18	4
25	25	65	300	52	185	145	18	8
40	25	80	300	56	200	160	18	8
60	16	100	360	68	235	180	18	8
60	25	100	360	68	235	190	22	8

4.5 Integration in the Heating System

Please inspect and check all dimensions to be sure that there is sufficient space in the intended location for installation of the flow sensor.

Flush the system thoroughly before installing the flow sensor.

No minimum straight pipe sections are required upstream or downstream for the flow sensor.

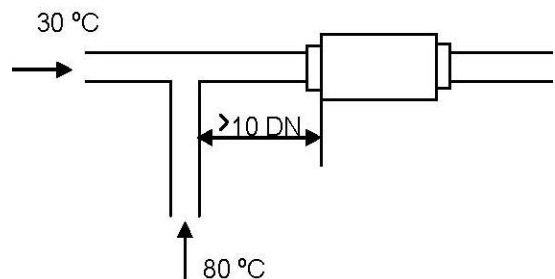

If the flow sensor is being installed in the common return flow of two heat systems, e.g. heating and hot water, the mounting location must be sufficiently separated from the T-piece, that is, at least 10 x DN from the T-piece, so that the different water temperatures are well-mixed before reaching the sensor.

Following the instructions in the illustrations below, mount the flow sensor horizontally or vertically between two close-off valves, making sure the arrow on the sensor corresponds to the actual direction of flow.

Mounting considerations

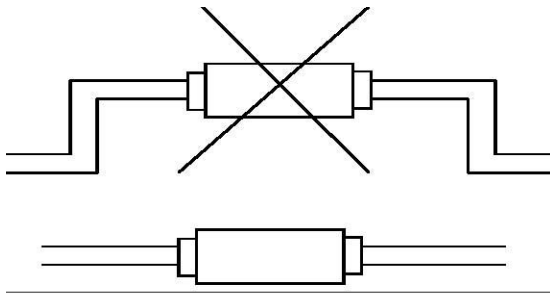

Avoid air pockets

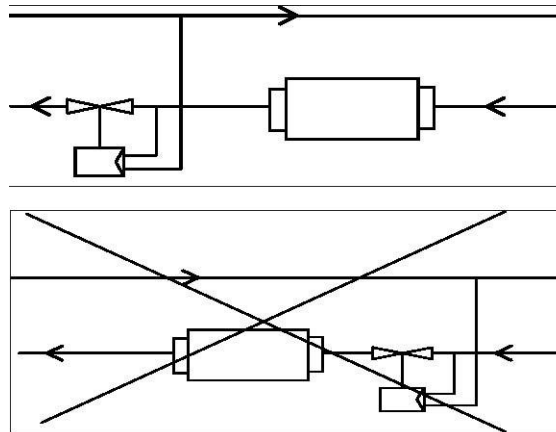

Install any valves or controllers downstream from the flow sensor

Connection pieces are to be sealed against manipulation.

5 Installation for Cooling Applications

When mounting the flow sensor for cooling applications make sure that the transducers (black housing) are to the side of, or under, the measuring tube (to prevent accumulation of condensation water). The flow sensor must always be mounted in the return flow. The calculator should be mounted on the wall, for example.

Attention must be paid that the cables connected to the calculator are laid such that condensation water cannot run along them and into the calculator. Cable loops should hang underneath.

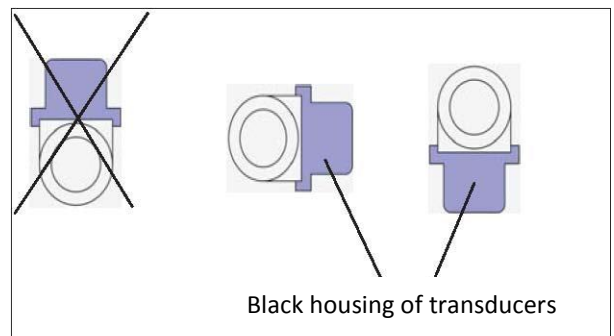

Mounting positions for cooling applications

6 Starting Up

- Open close-off valves. Check the heating system for leaks and vent thoroughly. After 100 seconds at the latest the flow sensor will begin to operate.
- When the response threshold has been exceeded and the flow is positive, volume pulses will be generated as determined by the instrument parameterization.
- Check the measured flow values on the connected calculator for plausibility.
- Vent the system until the flow display on the connected calculator is stable.
- Then affix the user seals on the connections.

6.1 Important Notes

Regulations for the application of meters are to be observed, see Standard EN 1434, part 6! In particular, cavitation must be avoided.

When installing the flow sensor, make sure to protect against overflow and dripping water

All technical data specified in the flow sensor data sheet and instructions must be adhered to.

The instrument identification and the seals required for verification of the flow sensor must not be damaged or removed – otherwise the guarantee and verification of the instrument no longer apply!

Transport of the flow sensor is only permissible in the original packaging.

7 Mounting of the Components

7.1 Mounting of the calculator

The housing cover can be opened by pulling the two snap-fit hooks at the base of the calculator (between the cable glands) towards you.

Before mounting, check to make sure that the cable lengths of the instruments to be connected are correct for the individual installation situation.

For existing mounting positions an optional adapter panel - meeting EN 1434-2:2007 (D) specifications – is available which makes it possible for the wall-mounting support to be mounted using standardized drill holes. The centre to centre drill hole separation for the wall-mounting unit and direct screw mounting is 119 mm.

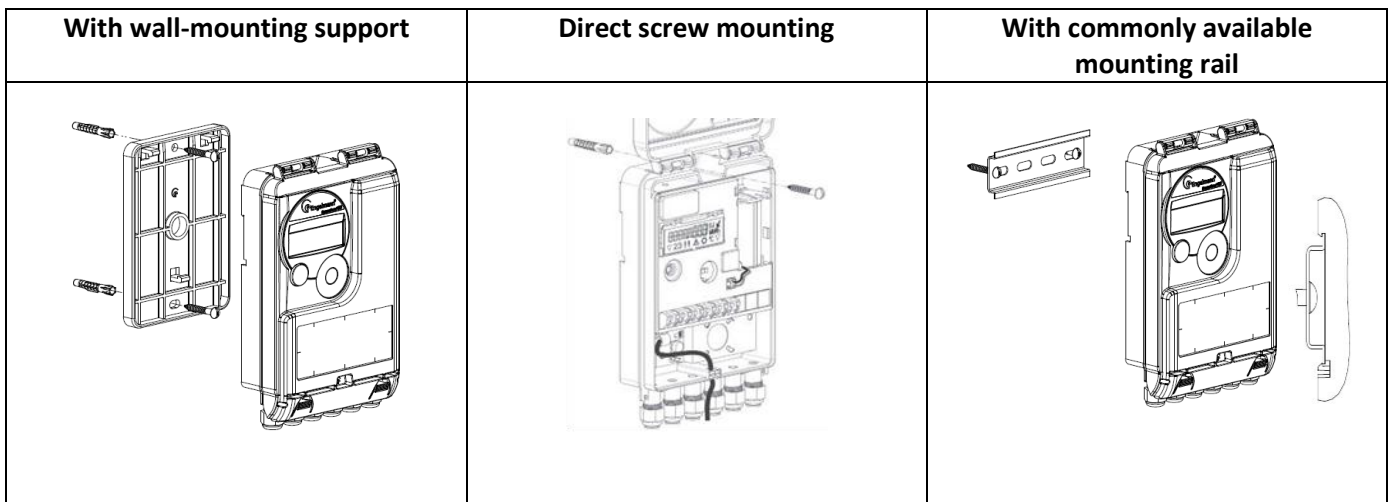

Attention

After the temperature sensors and flow meter have been connected the calculator must be sealed against manipulation. Please apply the enclosed self-lock seals and the seal-wires at the holes provided on the housing cover.

8 Connection of the components

8.1 Connection of the temperature sensors

Important

First mount the temperature sensors and then start running of the flow meter. This way unnecessary error messages can be avoided.

- Loosen two cable glands and glide them over the sensor cables. Remove the two blind plugs from the cable gland openings.
- Feed the temperature sensor cables through the appropriate openings of the cable glands into the terminal box.
- Clamp the wires as shown in the illustrations:

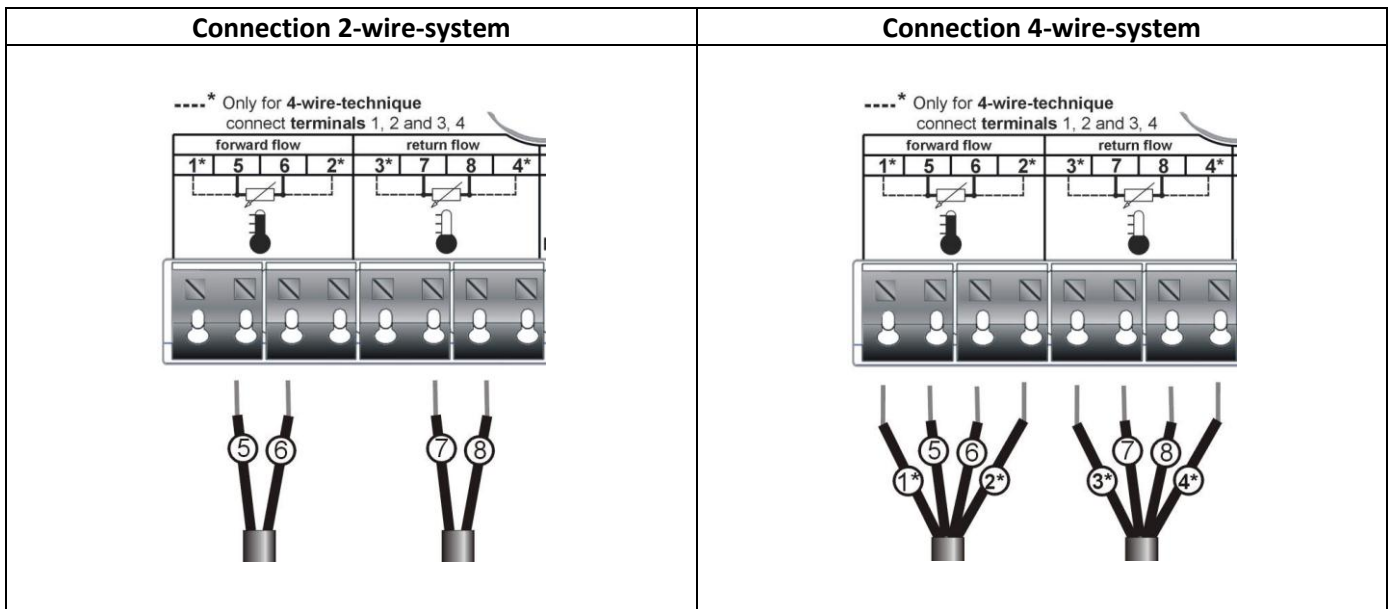

Cables that are too long should not be rolled up tightly into an 'air-core coil'. The cables should either be laid out disordered, or rolled up loosely into a wide coil which can be turned and tied into an '8'.

At delivery, the display shows 'ERR 03' until temperature sensors have been attached. This message disappears as soon as temperature sensors have been connected and the first measurement is carried out (every 30 seconds with flow, 10 minutes without flow).

Recognition of switched temperature sensors is only activated for meters which are purely heat meters or cooling meters. Recognition of switched sensors is not possible for dual-purpose heat/cooling meters.

The calculator connections have been designed to meet the valid standard EN 1434-2. All terminal strips have been labelled according to this standard.

The terminal strips are located under the cover of the calculator housing.

9 Start of Operation

- Slowly open the shut-off valves.
- Check that there are no leaks.

Check the following points:

- Are all the shut-off valves open?
- Is the meter of the right size?
- Is the heating (heating/cooling) system clear (dirt filters not clogged)?
- Does the directional arrow on the flow sensor match the actual direction of flow?
- Is a flow volume displayed?
- Is a plausible temperature difference displayed?













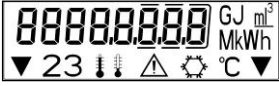

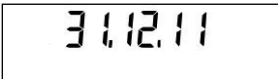
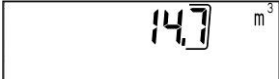







When the meter is functioning properly, attach the seals to the calculator, the temperature sensors and the flow sensor (required to protect against manipulation).

10 Display











The calculator has a liquid crystal display with 8 digits and special characters. The values that can be shown are divided into three display loops. All data is retrieved using the push button next to the display.

At the start you are automatically in the main loop (1st level). By pressing the push-button longer than 4 seconds you change to the next display loop. Keep the push-button pressed until you reach the desired information loop. By pressing the push-button briefly you can scan all the information within a loop. After 1 minute of non-use of the push-button, the display automatically returns to the main loop.

Level 1/Main loop

  1) Standard display: total heat energy; alternating display: cooling energy (for heating/cooling meter)	 2) Segment test, all segments triggered simultaneously	  3) Heat energy at last reading date alternating with last reading date ¹	 4) Total flow volume in m ³
 5) Current power in kW	 6) Current flow in m ³ /h	 7) Current date	  8) Information message (alternating binary and hexadecimal display)
 9) Selectable customer-set calculator no. (secondary address); factory setting is the serial number	    10) Tariff register 1: Value alternating with tariff register no. and criteria ²	   11) Tariff register 2: Values alternating with tariff register no. and criteria ²	  12) Momentary reading of the pulse counter 1 alternating with the pulse value ²
  13) Momentary reading of the pulse counter 2 alternating with the pulse value ²			

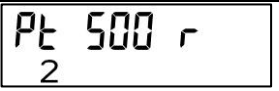
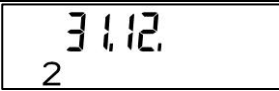
Level 2/Technician's loop

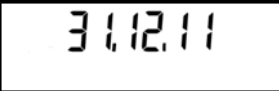
 1) Current forward flow temperature in °C	 2) Current return flow temperature in °C	 3) Temperature difference	 4) Days since first verification of calculator
 5) Pulse value of calculator	 6) M-Bus address (primary address)	 7) Serial number	 8) Software/firmware version
 9) Set billing date	 10) Set billing date	 11) Set billing date	 12) Set billing date

<div style="border: 1px solid black; padding: 2px; display: inline-block;">Pt 500 u 2</div> 9) Return flow or forward flow temperature sensor type and mounting position		<div style="border: 1px solid black; padding: 2px; display: inline-block;">3112.11</div> <div style="border: 1px solid black; padding: 2px; display: inline-block;">2 6.869 kW</div> 11), 13), 15) Maximum power value alternating with date and time of occurrence	<div style="border: 1px solid black; padding: 2px; display: inline-block;">2 140</div> <div style="border: 1px solid black; padding: 2px; display: inline-block;">2 1853 m³/h</div> 12), 14), 16) Maximum flow value alternating with date and time of occurrence
---	--	---	--

Level 3/Statistics Loop

<div style="border: 1px solid black; padding: 2px; display: inline-block;">3 2.785 M Wh</div> 1) Previous reading date alternating with its value. Alternatively, the total volume or tariff values can be displayed ¹ .	<div style="border: 1px solid black; padding: 2px; display: inline-block;">3112.10</div>	<div style="border: 1px solid black; padding: 2px; display: inline-block;">3 2638 M Wh</div> 2-16) Monthly values: Dates alternating with their values. Alternatively, the total volume or tariff values can be displayed ¹ .	<div style="border: 1px solid black; padding: 2px; display: inline-block;">3110.11</div>
--	--	---	--

¹Up to the end of the month the consumption and reading date for that month will be shown as 0.

²It can be set using the software "Device Monitor". A dedicated meter password is necessary. The password is available from the manufacturer.

11 Technical Data

Calculator		
Ambient temperature	°C	5 to 55
Temperature range	°C	1 to 150 (1 to 180)
Temperature difference heat	K	3 to 100 (3 to 130 for temperature range 1 to 180 °C)
Temperature difference cooling	K	-3 to - 50
Calculation of heat from	K	$\Delta\theta > 0.05$
Calculation of cooling from	K	$\Delta\theta < -0.05$
Dual-purpose heat/cooling meter	K	$\Delta\theta_{HC} < -0.5$
Resolution temperature	°C	0,01
Measurement cycle	sec	30; (4 with external power supply)
Power supply	V	3.6 lithium battery (standard version); 3 (external power supply)
Battery lifetime, estimated	years	Standard: 10 years; 6 years + 1 with pulse output: see "Influencing_factors_battery_lifetime".
Display		LCD 8 digits + special characters
Units		MWh (standard); kWh; GJ (optional)

12 Optical (infrared) interface

For the communication with the optical interface an optocoupler and the Device Monitor is necessary. The optocoupler and the, Device Monitor' software are available as accessory equipment.

Baud rate: 2400 baud

The optical infrared interface is activated by pressing the push-button.



If within 60 seconds neither a valid telegram is received nor the push-button pressed again, the interface is deactivated. The number of read-outs via the optical interface is limited to 300 times per day.

13 Additional Interfaces and Power Supply

13.1 Connection of additional interfaces and power supply

The following are options that the calculator can be equipped with at the factory (state when ordering) and will vary depending on the individual calculator.

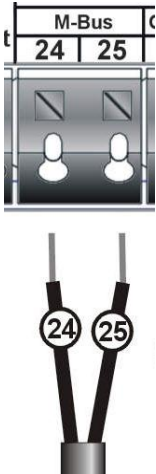
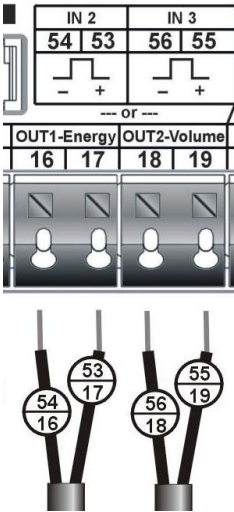
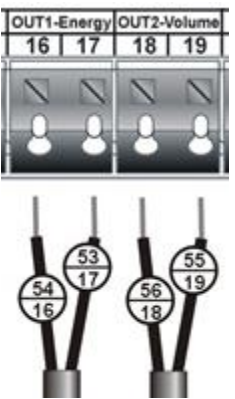
- Feed the cable to be connected (cable diameter 3.5 to 6.5 mm) through an opening on the bottom edge of the calculator housing into the space containing the terminal strips.
- Loosen a cable gland and glide it over the cable (cable diameter 3.5 to 6.5 mm). Remove the blind plug in the cable gland opening.
- Feed the cable of the through the opening into the terminal box.
- The terminal clamps are designed to fit strands with ends with a cross-section of 0.5 – 1.5 mm².
- Clamp on the cable according to the following illustrations that apply depending on the interface.

Connection of M-Bus	Connection of pulse outputs or inputs	Connection of pulse outputs heat/cooling	Connection of power pack
 <p>Polarity is not important for these connections so the wires can be clamped arbitrarily.</p>	 <p>Depending on the option, there are two additional pulse inputs (IN 2 and IN 3) for further meters or two pulse outputs (OUT 1 and OUT 2) for connection to an additional system. For connection of meters with open collectors attention must be paid to the polarity.</p>	 <p>For the dual-purpose heat/cooling meter version, separate pulse outputs for heating energy (OUT 1) and cooling energy (OUT 2) are available.</p>	 <p>It is strongly recommended to use only the manufacturer's original power pack. It is imperative to pay attention to the polarity.</p>

- Check that the connections are tight.
- Screw the cable glands tight by hand.

13.2 M-Bus (optional)

The M-Bus is a galvanically isolated interface for the transmission of meter data (absolute values).

13.2.1 General information about the M-Bus interface

It is important to note that the acknowledged state of the art technology rules and the relevant legal restraints (international and local; see 13.2.2 “Relevant norms, standards and literature on the M-Bus”) are to be observed.

The installation has to be performed by authorized, skilled persons.

If the regulations and the information in the installation and operating instruction manuals are not strictly followed, or if the installation is shown to be faulty, any resulting expenses will be charged to the company responsible for the installation.

Recommended type of cable: Telephone cable J-Y(ST)Y 2x2x0.8mm².

It is important to make sure that the topology of the M-Bus network (cable lengths and cross-sections) is suitable for the **baud rate (2400 Bd)** of the end instruments.

Further information can be found in the detailed ‘Application Note M-Bus’ at www.engelmann.de.

13.2.2 Relevant norms, standards and literature on the M-Bus

IEC 60364-4-41 (2005-12)	Low-voltage electrical installations - Part 4-41: Protection for safety - Protection against electric shock
IEC 60364-4-44 (2007-08)	Low-voltage electrical installations - Part 4-44: Protection for safety - Protection against voltage disturbances and electromagnetic disturbances
IEC 60364-5-51 (2005-04)	Electrical installations of buildings - Part 5-51: Selection and erection of electrical equipment - Common rules
IEC 60364-5-54 (2011-03)	Low-voltage electrical installations - Part 5-54: Selection and erection of electrical equipment - Earthing arrangements and protective conductors
EN 50310 (2010)	Application of equipotential bonding and earthing in buildings with information technology equipment
EN 13757-1:2002, 2:2004, 3:2004	Communication systems for meters and remote reading of meters
The M-Bus	A Documentation, Version 4.8, M-Bus User group
TI Technical Journal	Texas Instruments Technical Journal Vol. 8, 1991 M-Bus

13.2.3 Additional technical specifications

The installation has to fulfil the requirements of the relevant norms, standards and literature (see paragraph 13.2.2) and the specifications as follows:

Maximum voltage M-Bus	42 V
Minimum voltage M-Bus	21 V
Maximum ripple voltage	200 mV; EN 13757-2:2004; 4.3.3.6
Maximum voltage potential differences	2 V

13.2.4 Technical data M-Bus

Primary address	0 (factory setting); 1 – 250 (configurable)
Baud rate	2400; 300 (auto speed detect)

13.2.5 Number of read-outs

The number of possible read-outs depends on the number of instruments in the M-Bus network

Number of instruments in network	Read-outs per day primary address	Read-outs per day secondary address (without using SND NKE)
3	655	275
20	485	170
60	300	90
120	190	52
250	105	27

Table is only valid for Baud rate 2400!

If fewer read-outs are carried out, the unused ,credit' is stored in the instrument and can be used later.

During M-Bus communication with the calculator the other interfaces (push-button, optical interface) of the device cannot be used.

13.2.6 M-Bus addresses

Calculators with the M-Bus option can be addressed primarily or secondarily.

Both addresses can be set via the optical interface using the Device Monitor or via the M-Bus interface.

The factory setting of the ID-No. (secondary address) is identical to the serial no.

13.3 Radio interface wireless M-Bus EN 13757-3, EN 13757-4 (optional)

The radio interface is for the transmission of meter data (absolute values).

General information about the radio interface

Installation of radio components between or behind heating pipes, or the presence of other bulky obstacles directly over or in front of the housing must be avoided.

The transmission quality (range, telegram processing) of radio components can be negatively influenced by instruments or equipment with electromagnetic emissions, such as telephones (particularly LTE mobile radio standard), Wi-Fi routers, baby monitors, remote control units, electric motors, etc.

In addition, the construction of the building has a strong influence on the transmission range and coverage.

Furthermore, when using installation boxes (substations) they must be equipped with non-metallic covers or doors.

The factory-setting of the meters clock is standard (winter) Central European Time (GMT +1). There is no automatic changeover to daylight savings (summer) time.

The radio function is deactivated upon delivery (factory-setting). See section 0 “*Factory settings may vary from the above.

Activation of the radio interface”.

13.3.1 Technical data radio

Frequency	868 MHz
Transmission power	up to 12 dBm
Protocol	wireless M-Bus based on EN 13757-3
Selectable modes	S1/T1/C1
Telegrams	<ul style="list-style-type: none"> - Short telegram conform to AMR (OMS-Spec_Vol2_Primary_v301): energy (heat/cooling energy, pulse input 1, pulse input 2), total volume, flow, power, information message, return flow temperature, temperature difference - Long telegram for walk-by read-out: energy (heat/cooling energy, pulse input 1, pulse input 2), total volume, information message, 15 monthly values
Encryption	AES: Advanced Encryption Standard; key length: 128 bits

13.3.2 Radio configuration*

Parameter	Possible settings	Factory setting
Mode	S1/T1/C1; unidirectional	T1 (unidirectional)
Transmission period	00:00 - 24:00; any time period in the day	7:00 am - 7:00 pm
Transmission interval	120 seconds - 240 minutes	120 seconds (heat meters)
Weekdays	Monday – Sunday (any weekday)	Monday - Friday
Weeks in a month	1 – 4 (4: uninterrupted, incl. a possible 5 th week)	1 – 4 (4: uninterrupted)
Months	1 - 12	1 - 12
Radio activation date	01.01 - 31.12. (day. Month)	not set
AES-128- Encryption	<ul style="list-style-type: none"> - Not encrypted; - Encrypted: <ul style="list-style-type: none"> - Master Key 	Master Key; not activated

	- random key per instrument	
Type of telegram	- Short telegram in conformity to AMR (OMS-Spec_Vol2_Primary_v301) - Long telegram for walk-by read-out	Short telegram (AMR)

*Factory settings may vary from the above.

13.3.3 Activation of the radio interface

The radio interface **leaves the factory deactivated**. It can be activated as follows:

- Without using additional software the radio function can be activated by pressing the push-button for over 3 seconds while the display is showing the item 'M-Bus address', (see section 10 "Display" Level 2/Technician's Loop). The standard factory-settings will be activated. 
- The radio function can also be activated using the software 'Device Monitor'. This software can be ordered separately as an option. The exact procedure for activating the radio function using this software is described in the accompanying handbook.

After successful activation of the radio function a black triangle will appear permanently in the lower left corner of the display.

If using the compact mode, for one hour after activation the meter will transmit in installation mode. This means that format telegrams and compact telegrams will be send alternately. During installation mode at least one meter of the version being installed (forward or return flow, heat or cooling or heat/cooling, pulse inputs, display units) must be received by the Engelmann Read-out Software. The format of the telegram will be stored locally in the PC in an .xml file. After completion of the installation mode only compact telegrams will be transmitted.

13.4 Two additional pulse inputs (optional; only in conjunction with M-Bus or radio)

With this option, additional instruments with pulse outputs can be read out via M-Bus or radio.

General information about pulse inputs:

It is important to note that the acknowledged state of the art technology rules and the relevant legal restraints (international and local; see 13.4.1 "Relevant norms, standards and literature on the pulse inputs") are to be observed.

The installation has to be performed by authorized, skilled persons.

If the regulations and the information in the installation and operating instruction manuals are not strictly followed, or if the installation is shown to be faulty, any resulting expenses will be charged to the company responsible for the installation.

13.4.1 Relevant norms, standards and literature on the pulse inputs

IEC 60364-4-41 (2005-12)	Low-voltage electrical installations - Part 4-41: Protection for safety - Protection against electric shock
IEC 60364-4-44 (2007-08)	Low-voltage electrical installations - Part 4-44: Protection for safety - Protection against voltage disturbances and electromagnetic disturbances
IEC 60364-5-51 (2005-04)	Electrical installations of buildings - Part 5-51: Selection and erection of electrical equipment - Common rules
IEC 60364-5-54 (2011-03)	Low-voltage electrical installations - Part 5-54: Selection and erection of electrical equipment - Earthing arrangements and protective conductors
EN 50310 (2010)	Application of equipotential bonding and earthing in buildings with information technology equipment
EN 1434-2 2007	Heat Meters — Part 2: Constructional requirements

13.4.2 Technical data pulse inputs

Pulse input class	CMOS; IB according to EN 1434-2:2007
Internal pull-up voltage	+ 3 V DC
Internal pull-up resistance	2 MΩ
Current	= 1.5 μA
High-level threshold	$U \geq 2 \text{ V}$
Low-level threshold	$U \leq 0.5 \text{ V}$

13.4.3 Electrical requirements on the pulse output of the instrument to be connected (e.g. flow meter)

Pulse output class	(passive) output OA (reed contact/electronic switch) or OC (open collector) according to EN 1434-2:2007
Pulse length "on"	$\geq 100 \text{ ms} \leq 150 \text{ ms}$ (for electronic switches)
Pulse length "off"	$\geq 100 \text{ ms}$
Current	= 1.5 μA
Resistance "contact open"	$\geq 6 \text{ M}\Omega$
Resistance "contact closed"	$\leq 3 \text{ k}\Omega$

13.4.4 Setting up the two additional pulse inputs

The optional pulse inputs 1 + 2 for external meters can be set up using the Device Monitor configuration software. The input pulse value, the units and the starting values of the external meters can be configured.

13.4.5 Set-up possibilities

Pulse value	Units
1	litres/kWh/pulse without unit
2.5	litres/kWh/pulse without unit
10	litres/kWh/pulse without unit
25	litres/kWh/pulse without unit
100	litres/kWh/pulse without unit
250	litres/kWh/pulse without unit
1000	litres/kWh/pulse without unit

Installation notes for pulse inputs

It is important that the pulse cables are not be affected by (or exposed to) the M-Bus voltage!

Check the polarity of pulse generators with 'open collector' outputs.

The cable wires must not touch each other during installation; otherwise pulses will be counted in the instrument.

When setting up the meter it may be necessary to adjust the meter reading of the instruments connected and the pulse value using the Device Monitor software.

13.5 Potential-free pulse output (optional)

The potential-free pulse output is an electronic switch which outputs pulses that can be used for any purpose.

The pulse output contact closes, corresponding to the pulse value defined by the resolution of the displayed value (see next passage).

13.5.1 Pulse output for energy (OUT1-Energy)

One pulse is generated by the pulse output for energy when the last digit of the energy display is increased by one.

The pulse value is automatically determined by the last digit of the energy display.

The pulse units are identical to the units of the energy display:

- Example 1: Display 12345678 kWh => pulse value for energy pulse output = 1 kWh/pulse
- Example 2: Display 12345,678 MWh => pulse value for energy pulse output = 0,001 MWh/pulse (1 kWh/pulse)

- Example 3: Display 1234567,8 GJ => pulse value for energy pulse output = 0,1 GJ/pulse

13.5.2 Pulse output for volume (OUT2-Volume)

One pulse is generated by the pulse output for volume when the second-to-last digit of the volume display is increased by one.

The pulse value is automatically determined by the second-to-last digit of the volume display. The pulse units are identical to the units of the volume display.

- Example 1: Display 12345,678 m³ => pulse value for volume pulse output = 0,01 m³/pulse
- Example 2: Display 12345678 l => pulse value for volume pulse output = 10 l/pulse

13.5.3 Pulse outputs for calculator with combined heat/cooling measurement

For this type of calculator the outputs OUT1 and OUT2 are both outputs for energy.

The behaviour is the same as described in chapter 13.5.1.

OUT1 is the output for the pulses for heat energy.

OUT2 is the output for the pulses for cooling energy.

13.5.4 Technical data pulse output

Pulse output class	OA (electronic switch) according to EN 1434-2:2007
Pulse values	See chapter 13.5.1 to 13.5.3
Peak switching current	300 mA ~/-
Switching voltage, maximum	35 V ~/-
Switching power, maximum	300 mW
Contact isolation	> 10 ⁹ Ohm
Contact resistance (on)	max. 25 Ohm
Contact capacity	1.5 pF
Maximum current	120 mA
Withstand voltage (open contact)	350 V ~/-
Closing time	125 ms
Min. close-open-time	125 ms

14 Information Messages



When the instrument has detected an information message, the message symbol is displayed: 

The specific message can be found at the menu item 8 'Information message' in Level 1/Main loop (see section 10 "Display").

The instrument recognizes seven message causes, which can also occur in combination with each other. The messages are shown on the display. The message code is displayed alternately in binary and hexadecimal form.

Binary display	Description	Hexadecimal display
1 at first place	Checksum fault	H 40
1 at second place	E ² PROM defective	H 20
1 at third place	Reset	H 10
1 at fourth place	Temperature difference	H 08
1 at fifth place	Internal calibration defective	H 04
1 at sixth place	Return flow sensor defective	H 02
1 at seventh place	Forward flow sensor defective	H 01

Example: Temperature sensor switched

Message	Checksum fault	E ² PROM fault	Reset	Temperature difference	Internal calibration error	Return flow sensor fault	Forward flow sensor fault	Alternating hexadecimal message displayed (LCD)
Bit	6	5	4	3	2	1	0	
Display location	1	2	3	4	5	6	7	
Alternating binary message displayed (LCD)								

When a message sign appears in the standard display (total heat, total cooling or alternating total heat and cooling energy), with the exception of the messages 'reset' (10), (01), (02), (03), (08) and (18), the instrument must be exchanged and sent to the supplier for examination.

14.1 Message description

Message	Effect	Possible cause
Ff-sensor fault	No calculations are carried out. The registers for flow and energy are not being updated (no new data is being stored).	Sensor cable severed; sensor cable shorted circuited.
Rf-sensor fault	No calculations are carried out. The registers for flow and energy are not being updated (no new data is being stored).	Sensor cable severed; sensor cable shorted circuited.
Internal calibration error	There is no energy calculation. The registers for flow and energy are not being updated (no new data is being stored).	Defective component.
Temperature difference wrong (Only for heat or cooling meter)	There is no energy calculation. Heat measurement needs positive temperature difference. Cooling measurement needs negative temperature difference	<ul style="list-style-type: none"> - Temperature sensors switched - If the pump system is not active the temperature difference might be inverted.
Reset	The measurements since the last storage of data in the E ² PROM are lost (maximum one day).	<ul style="list-style-type: none"> - EMI (electromagnetic interferences) - Low battery
E ² PROM fault	After a reset, the instrument is without function.	Defective component.
Checksum fault	No calculations are carried out. The registers of flow and energy are not being updated.	Defective component.

15 MID Declaration of Conformity

For the product described in this document we confirm, as the manufacturer, that it meets the fundamental requirements of the following directives:

- Directive 2004/22/EC of 31 March 2004 on measuring instruments, in particular those in Annex MI-004
- Directive 2004/108/EC on EMC
- Directive 2006/95/EC on low voltage
- Directive 1999/5/EC (R&TTE)

The complete signed declaration can be found at www.engelmann.de.

16 Manufacturer

Engelmann Sensor GmbH
Rudolf-Diesel-Str. 24-28
69168 Wiesloch-Baiertal
Germany
Tel: +49 (0)6222-9800-0
Fax: +49 (0)6222-9800-50
E-Mail: info@engelmann.de
www.engelmann.de

17 Contact

Maddalena S.p.A.
Via G.B. Maddalena, 2/4
33040 Povoletto (UD) – Italy
Tel.: +39.0432.634811
Fax.: +39.0432.679820
www.maddalena.it

Subject to technical change.